



24

	SERVICE →
	(0) 91 23 95 50
	(0) 17 18 11 43 24
	(0) 91 23 18 51 55
	(0) 91 23 18 52 19
	(0) 91 23 30 85
	Service + Spare parts
	e-mail: service@tadanofaun.de
	e-mail: spareparts@tadanofaun.de
	D → 00 49
A	B CH DK F
GB	I N NL P
E 07 49	S 00 949

ALL-TERRAIN ATF 70-4

ISO 9001

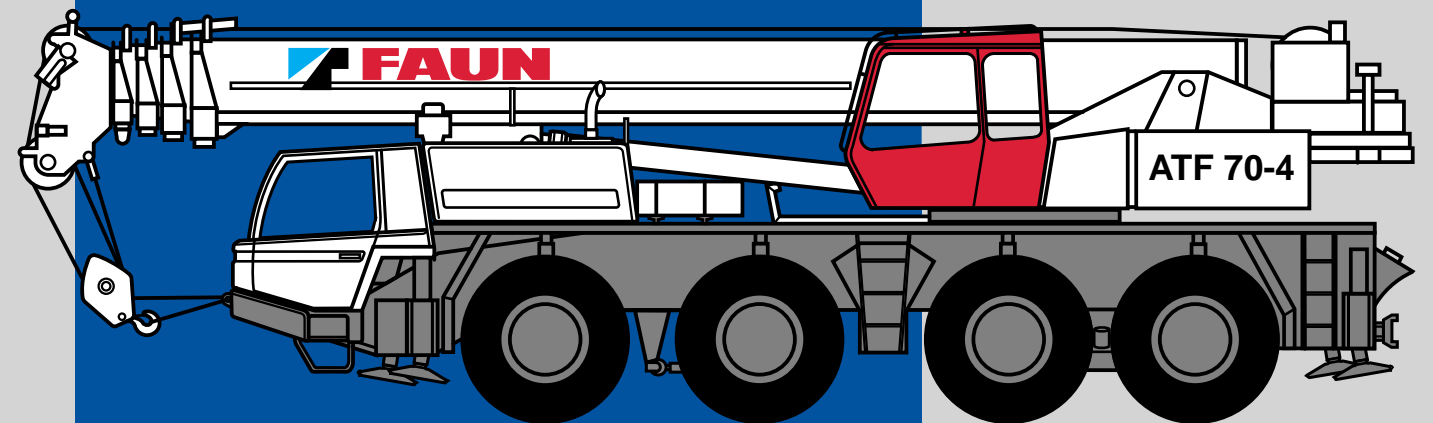

TADANO FAUN GmbH
 Postfach 10 02 64
 D-91205 Lauf/Germany
 Tel. (0) 91 23 95 50
 Fax (0) 91 23 30 85
<http://www.tadanofaun.de>
 e-mail: info@tadanofaun.de

REAL
 GUINDASTES E EQUIPAMENTOS





TADANO FAUN

ATF 70-4

Maße / Dimensions / Dimensions / Dimensiones (mm)
Gewichte / Weights / Poids / Pesos
Geschwindigkeiten / Speeds / Vitesses / Velocidades

 16.00 R 25

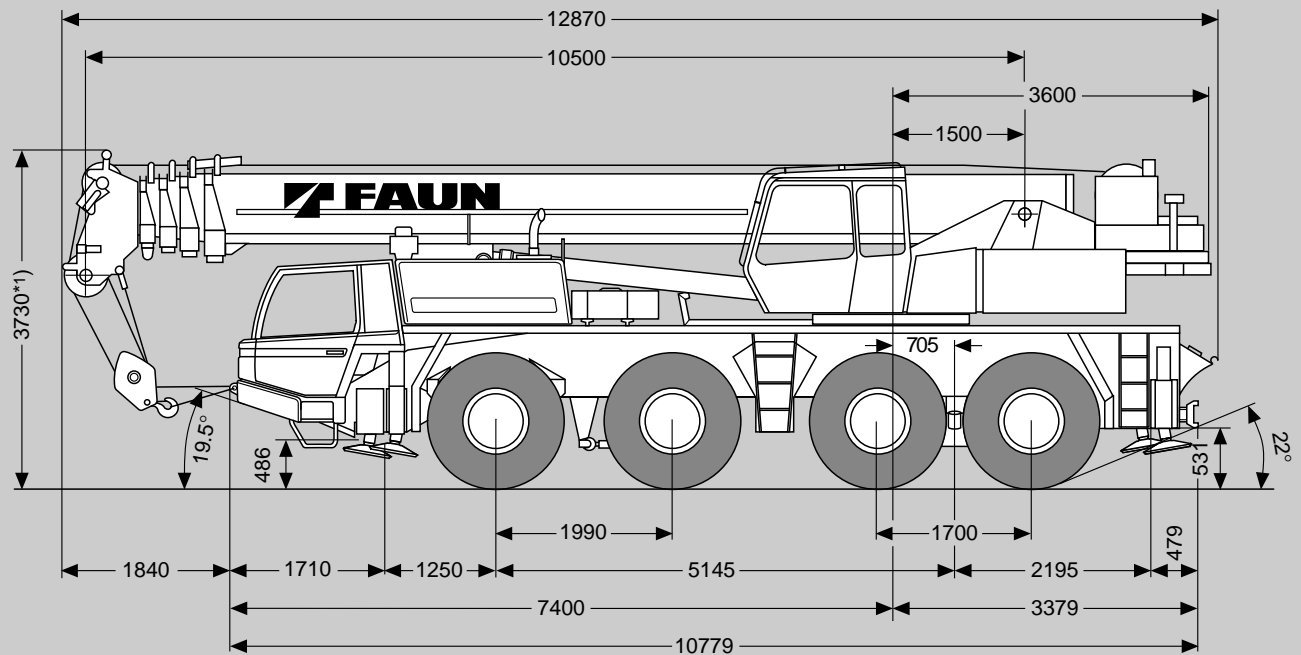

*1) -120 mm/+150 mm

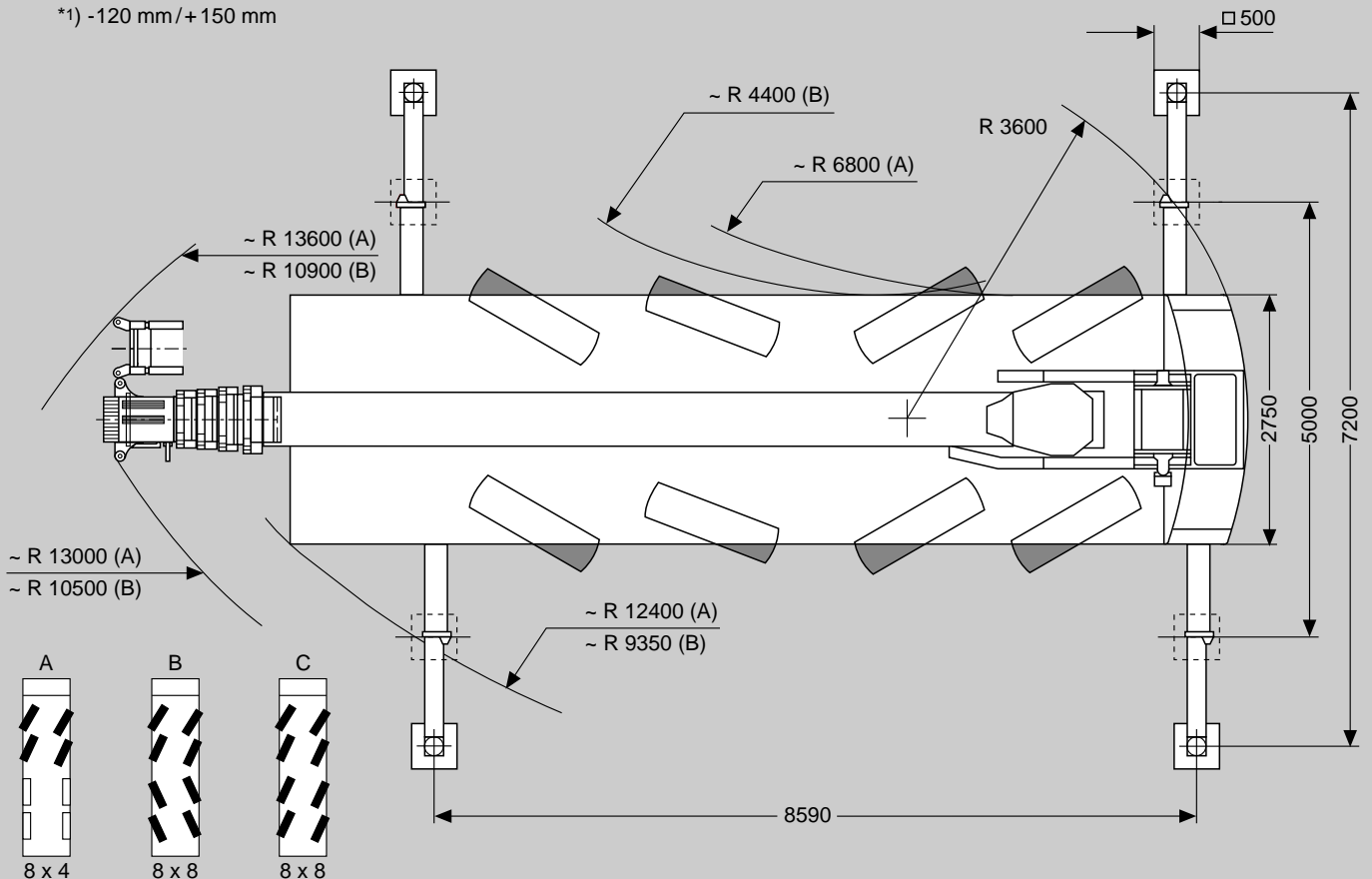

~ R 13000 (A)
~ R 10500 (B)

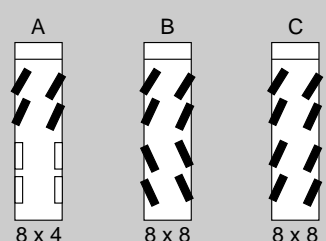

**TADANO FAUN****ATF 70-4**

Gewichte / Geschwindigkeiten
Weights / Working speeds
Poids / Vitesses
Pesos / Velocidades de trabajo

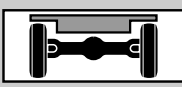
	Achse / Axle Essieu / Eje	1	2	3	4	Gesamtgewicht / Total weight Poids total / Peso total
	(t)	11.8	11.8	11.7	11.7	47*

* Incl. 7,7 t Gegengewicht, Bereifung 16.00 R 25, 9,0 m / 16,0 m Gitterspitze, 40 t Hakenflasche, 6 t Hakengeschirr, Antrieb 8 x 6.

* Incl. 7.7 t counterweight, tyres 16.00 R 25, 9.0 m / 16.0 m folding swingaway, 40 t hook block, 6 t swivel hook, drive 8 x 6.

* Incl. de 7,7 t contrepoids, pneus 16.00 R 25, 9,0 m / 16,0 m extension treillis, 40 t moufle, 6 t élingues, entraînement 8 x 6.

* Incl. contrapeso de 7,7 t, neumáticos 16.00 R 25, plumin articulado, gancho de 40 t, 6 t gancho de bola, tracción 8 x 6.

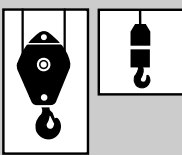
	Traglast / Lifting capacity / Force de levage / Capacidad de elevación	Rollen / Sheaves Pulies / Poleas	Stränge / Parts of line Brins / Ramales de cable	Gewicht / Weight Poid / Peso
	63 t *	5	11	600 kg
	40 t *	3	7	400 kg
	40 t	3	7	400 kg
	20 t	1	3	200 kg
	6 t	-	1	150 kg





* Doppelhaken



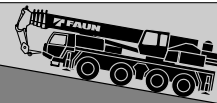

* Rams horn

* Moufle avec crochet marin

* Gancho doble

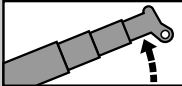
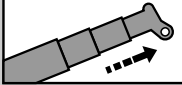

	1	2	3	4	5	6	R	
km/h 	0 - 12	27	36	52	72	80	0 - 12	37%
km/h 	0 - 7	15	21	30	41	49	0 - 7	61%
	16.00 R 25							

V+ 	Stufenlos Infinitely variable Progressivement variable Infinitamente variable	Seil Rope Câble Cable	Max. Seilzug Max. single line pull Effort maxi au brin simple Trio máximo por ramal
	0 - 112 m/min für einfachen Strang single line au brin simple ramal simple	18 mm / 200 m	68 kN
	0 - 85 m/min für einfachen Strang single line au brin simple ramal simple	16 mm / 170 m	55 kN
	0 - 2 min ⁻¹		
	-2° to +80°	ca. 35 s approx. 35 s env. 35 s aproximadamente 35 s	
	10.5 m to 40.5 m	ca. 155 s approx. 155 s env. 155 s aproximadamente 155 s	



TADANO FAUN

ATF 70-4

Tragfähigkeiten am Teleskopausleger
Lifting capacities on telescopic boom
Capacités de levage à la flèche télescopique
Capacidades de elevación con la pluma telescópica

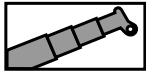

DIN / ISO

 m	10.5 m**	10.5 m	14.2 m	18.0 m	18.0 m	25.5 m	25.5 m	33.0 m	33.0 m	36.0 m	37.5 m	40.5 m
3.0	70.0***											
3.0	60.0	55.0										
3.5	56.0	50.5										
4.0	51.2	46.7	38.0	32.0	28.0							
4.5	46.8	43.3	38.0	32.0	28.0							
5.0	41.0	40.4	38.0	32.0	28.0	20.0	15.0					
6.0	30.8	34.5	33.8	32.0	27.1	20.0	15.0	13.5	11.0			
7.0	23.5	29.2	28.5	28.4	24.3	19.0	14.6	13.5	11.0	12.0	10.0	
8.0	18.7	25.2	24.4	24.4	22.1	18.1	14.2	13.5	10.5	12.0	10.0	9.0
9.0			21.3	21.2	20.2	17.1	13.7	12.8	10.0	12.0	9.8	9.0
10.0			18.7	18.7	18.5	15.4	13.3	12.2	9.5	12.0	9.6	8.7
11.0			16.4	16.1	17.0	13.9	12.5	11.5	8.8	11.3	9.4	8.4
12.0			14.2	13.8	14.7	12.4	11.8	10.9	8.1	10.6	9.3	8.2
14.0				10.6	11.4	10.3	10.7	9.1	7.0	9.2	9.0	7.6
16.0				8.4	9.2	8.4	9.2	7.7	6.1	7.9	7.7	7.1
18.0						6.8	7.6	6.6	5.4	6.8	6.7	6.1
20.0						5.6	6.3	5.7	4.9	5.9	5.8	5.3
22.0						4.5	5.3	4.7	4.4	5.1	5.1	4.6
24.0								3.8	4.0	4.5	4.3	4.1
26.0								3.1	3.6	3.7	3.7	3.6
28.0								2.5	3.3	3.0	3.0	3.1
30.0								2.0	3.0	2.5	2.5	2.6
32.0										2.1	2.1	2.2
34.0										1.7	1.8	1.8
36.0												1.4
38.0												1.2

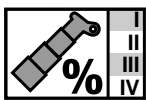
I
II
III
IV

0	0	50	50	0	100	50	100	0	100	100	100	100
0	0	0	50	50	50	50	100	100	80	87	100	100
0	0	0	0	50	50	50	100	100	80	87	100	100
0	0	0	0	0	0	50	0	100	80	87	100	100

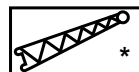
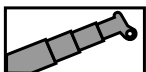

DIN / ISO

 m	34.5 m + 9.0 m			37.5 m + 9.0 m			40.5 m + 9.0 m			40.5 m + 16.0 m		
	4°	15°	30°	4°	15°	30°	4°	15°	30°	4°	15°	30°
10.0	6.00	4.60		5.00			4.50					
11.0	6.00	4.60		5.00			4.50					
12.0	6.00	4.60	3.20	5.00	4.30	3.10	4.50	3.70		2.50		
14.0	5.19	4.10	2.99	5.00	4.30	3.10	4.10	3.70	3.00	2.50	2.10	
16.0	4.57	3.71	2.80	4.52	3.91	2.88	3.86	3.52	2.88	2.50	2.10	1.50
18.0	4.07	3.38	2.62	4.02	3.57	2.71	3.61	3.33	2.76	2.45	1.98	1.50
20.0	3.65	3.10	2.47	3.61	3.28	2.56	3.37	3.15	2.64	2.40	1.85	1.42
22.0	3.31	2.87	2.34	3.26	3.04	2.43	3.02	2.89	2.50	2.35	1.73	1.35
24.0	3.01	2.66	2.22	2.97	2.80	2.31	2.72	2.65	2.38	2.13	1.62	1.28
26.0	2.76	2.48	2.11	2.71	2.59	2.20	2.43	2.46	2.27	1.94	1.51	1.22
28.0	2.54	2.33	2.02	2.39	2.39	2.10	2.11	2.28	2.18	1.78	1.42	1.17
30.0	2.24	2.19	1.94	2.08	2.22	2.02	1.84	2.02	2.09	1.65	1.34	1.12
32.0	1.95	2.07	1.86	1.80	1.95	1.94	1.59	1.75	1.90	1.53	1.27	1.07
34.0	1.70	1.81	1.80	1.56	1.69	1.80	1.37	1.51	1.64	1.43	1.21	1.03
36.0	1.45	1.55	1.60	1.34	1.45	1.54	1.17	1.30	1.40	1.33	1.14	0.99
38.0	1.15	1.20	1.20	1.16	1.25	1.30	1.00	1.11	1.19	1.26	1.09	0.96
40.0	0.85	0.90	0.90	0.90	0.95	0.95	0.82	0.92	0.99	1.11	1.04	0.93
42.0				0.65	0.70	0.70	0.65	0.70	0.70	0.97	1.00	0.91
44.0				0.40	0.40	0.35	0.40	0.45	0.45	0.82	0.95	0.88
46.0										0.70	0.80	0.86
48.0										0.55	0.60	0.65
50.0										0.35	0.40	0.45

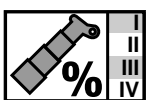
I
II
III
IV

100				100				100				100
73				87				100				100
73				87				100				100
73				87				100				100



TADANO FAUN

ATF 70-4

Hubhöhen
Lifting heights
Hauteurs de levage
Alturas de elevación

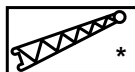
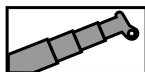

12.1t*

DIN/ISO

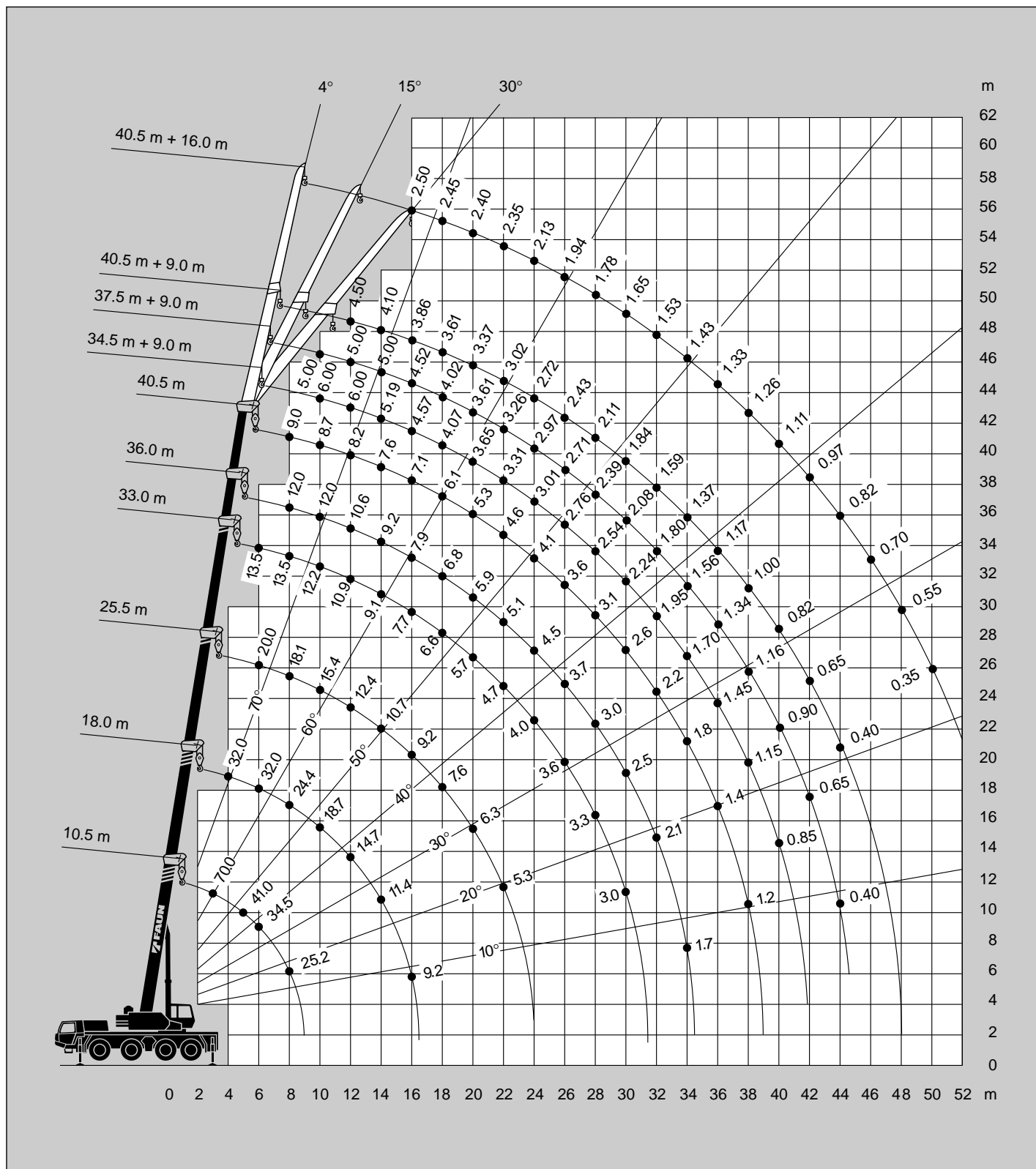

*) Gegen Mehrpreis
**) Abstützbasis 5.0 m
***) Nach hinten mit Zusatzausrüstung
*) Against extra charge
**) Outriggers mid extended to 5.0 m
***) Over rear with additional equipment

*) Contre supplément de prix
**) Base de calage 5.0 m
***) A l'arrière et avec équipement supplémentaire
*) Con suplemento de precio
**) Con los estabilizadores a medio extender a 5.0 m
***) Sobre la parte trasera con equipo adicional



TADANO FAUN

ATF 70-4

Tragfähigkeiten am Teleskopausleger

Lifting capacities on telescopic boom

Capacités de levage à la flèche télescopique

Capacidades de elevación con la pluma telescópica

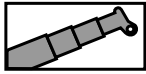

DIN / ISO

 m	10.5 m**	10.5 m	14.2 m	18.0 m	18.0 m	25.5 m	25.5 m	33.0 m	33.0 m	36.0 m	37.5 m	40.5 m
3.0	70.0***											
3.0	60.0	55.0										
3.5	55.4	50.4										
4.0	50.4	46.6	38.0	32.0	28.0							
4.5	44.9	43.3	38.0	32.0	28.0							
5.0	39.5	40.2	38.0	32.0	28.0	20.0	15.0					
6.0	27.8	33.1	32.3	32.0	27.1	20.0	15.0	13.5	11.0			
7.0	21.0	28.0	27.2	27.4	24.3	19.0	14.6	13.5	11.0	12.0	10.0	
8.0	16.6	24.1	23.3	23.6	22.1	18.1	14.2	13.5	10.5	12.0	10.0	9.0
9.0			20.5	20.4	20.2	17.1	13.7	12.8	10.0	12.0	9.8	9.0
10.0			17.1	17.0	17.9	15.4	13.3	12.2	9.5	12.0	9.6	8.7
11.0			14.6	14.4	15.2	13.9	12.5	11.5	8.8	11.3	9.4	8.4
12.0			12.6	12.4	13.2	12.4	11.8	10.9	8.1	10.6	9.3	8.2
14.0				9.3	10.2	9.4	10.3	9.1	7.0	9.2	9.0	7.6
16.0				7.2	8.2	7.4	8.2	7.5	6.1	7.9	7.7	7.1
18.0						5.9	6.7	6.0	5.4	6.8	6.7	6.1
20.0						4.7	5.5	4.8	4.9	5.4	5.4	5.3
22.0						3.7	4.5	3.8	4.4	4.4	4.4	4.5
24.0								3.0	4.0	3.6	3.6	3.7
26.0								2.4	3.6	2.9	2.9	3.0
28.0								1.8	3.2	2.4	2.4	2.5
30.0								1.3	2.7	1.9	1.9	2.0
32.0										1.5	1.5	1.6
34.0										1.1	1.2	1.2
36.0												0.9
38.0												0.7

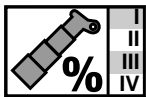
I
II
III
IV

I	0	0	50	50	0	100	50	100	0	100	100	100
II	0	0	0	50	50	50	50	100	100	80	87	100
III	0	0	0	0	50	50	50	100	100	80	87	100
IV	0	0	0	0	0	0	50	0	100	80	87	100

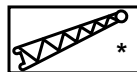
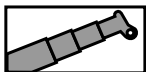

DIN / ISO

 m	34.5 m + 9.0 m			37.5 m + 9.0 m			40.5 m + 9.0 m			40.5 m + 16.0 m		
	4°	15°	30°	4°	15°	30°	4°	15°	30°	4°	15°	30°
10.0	6.00	4.60		5.00			4.50					
11.0	6.00	4.60		5.00			4.50					
12.0	6.00	4.60	3.20	5.00	4.30	3.10	4.50	3.70		2.50		
14.0	5.19	4.10	2.99	5.00	4.30	3.10	4.10	3.70	3.00	2.50	2.10	
16.0	4.57	3.71	2.80	4.52	3.91	2.88	3.86	3.52	2.88	2.50	2.10	1.50
18.0	4.07	3.38	2.62	4.02	3.57	2.71	3.61	3.33	2.76	2.45	1.98	1.50
20.0	3.65	3.10	2.47	3.61	3.28	2.56	3.37	3.15	2.64	2.40	1.85	1.42
22.0	3.31	2.87	2.34	3.26	3.04	2.43	3.02	2.89	2.50	2.35	1.73	1.35
24.0	3.01	2.66	2.22	2.97	2.80	2.31	2.72	2.65	2.38	2.13	1.62	1.28
26.0	2.76	2.48	2.11	2.71	2.59	2.20	2.43	2.46	2.27	1.94	1.51	1.22
28.0	2.54	2.33	2.02	2.39	2.39	2.10	2.11	2.28	2.18	1.78	1.42	1.17
30.0	2.05	2.20	1.94	2.08	2.22	2.02	1.84	2.02	2.09	1.65	1.34	1.12
32.0	1.65	1.75	1.85	1.65	1.75	1.85	1.59	1.75	1.90	1.53	1.27	1.07
34.0	1.30	1.40	1.45	1.30	1.40	1.45	1.25	1.35	1.45	1.43	1.21	1.03
36.0	0.95	1.00	1.05	0.95	1.05	1.10	0.95	1.05	1.15	1.33	1.14	0.99
38.0	0.70	0.70	0.75	0.70	0.75	0.80	0.65	0.75	0.80	1.20	1.09	0.96
40.0	0.45	0.45	0.40	0.45	0.45	0.50	0.45	0.50	0.50	0.95	1.04	0.93
42.0										0.70	0.80	0.91
44.0										0.50	0.60	0.70
46.0											0.40	0.50

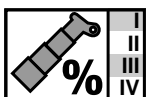
I
II
III
IV

I	100			100			100			100		
II	73			87			100			100		
III	73			87			100			100		
IV	73			87			100			100		



TADANO FAUN

ATF 70-4

Hubhöhen
Lifting heights
Hauteurs de levage
Alturas de elevación

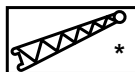
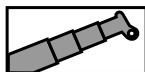

8.9t

DIN/ISO

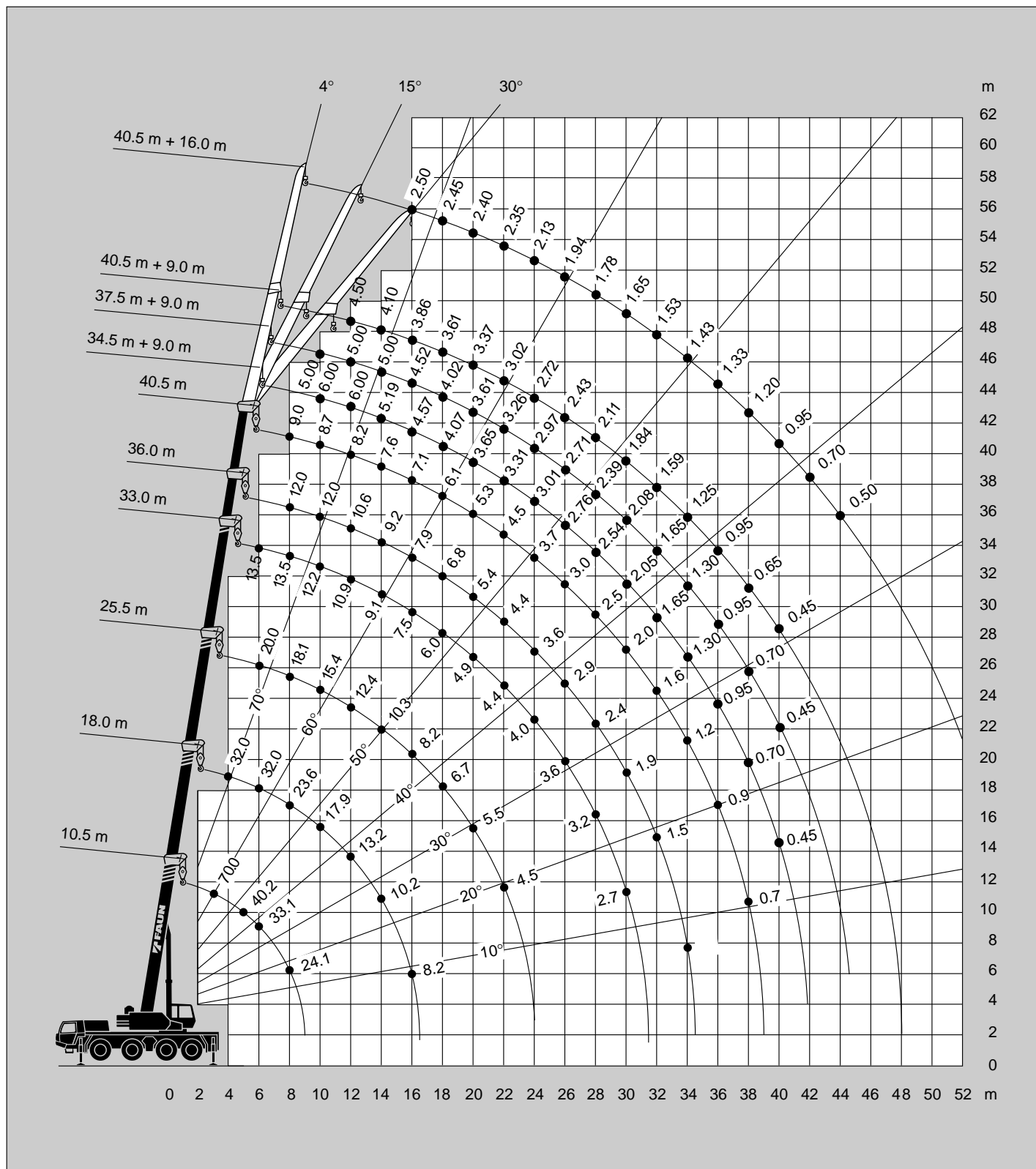

*) Gegen Mehrpreis
**) Abstützbasis 5.0 m
***) Nach hinten mit Zusatzausrüstung
*) Against extra charge
**) Outriggers mid extended to 5.0 m
***) Over rear with additional equipment

*) Contre supplément de prix
**) Base de calage 5.0 m
***) A l'arrière et avec équipement supplémentaire
*) Con suplemento de precio
**) Con los estabilizadores a medio extender a 5.0 m
***) Sobre la parte trasera con equipo adicional

**TADANO FAUN****ATF 70-4**

Tragfähigkeiten am Teleskopausleger
Lifting capacities on telescopic boom
Capacités de levage à la flèche télescopique
Capacidades de elevación con la pluma telescópica

		12.1t*		DIN/ISO
	m	10.5 m	18.0 m	
3.0		23.0		
3.5		21.0		
4.0		19.0	19.0	
4.5		17.5	17.5	
5.0		15.0	15.0	
6.0		11.5	11.5	
7.0		9.0	9.0	
8.0		7.5	7.5	
9.0			6.2	
10.0			5.3	
11.0			4.4	
12.0			3.7	
14.0			2.6	
16.0			1.7	
	%			
I		0	0	
II		0	50	
III		0	50	
IV		0	0	

		8.9t		DIN/ISO
	m	10.5 m	18.0 m	
3.0		23.0		
3.5		21.0		
4.0		19.0	18.0	
4.5		17.5	16.0	
5.0		15.0	14.5	
6.0		11.5	11.5	
7.0		9.0	9.0	
8.0		7.5	7.5	
9.0			6.2	
10.0			5.3	
11.0			4.4	
12.0			3.7	
14.0			2.6	
16.0			1.7	
	%			
I		0	0	
II		0	50	
III		0	50	
IV		0	0	

Anmerkungen zu den Traglasttabellen

Die Tragfähigkeiten im Festigkeitsbereich basieren auf DIN 15018 Blatt 2 und Blatt 3 und F.E.M.

Die Tragfähigkeiten im Standsicherheitsbereich entsprechen DIN 15019 Bl. 2 / ISO 4305 und pr EN 13000.

Die zulässige Windgeschwindigkeit beträgt maximal 15 m/sec.

Die Tragfähigkeiten sind in metrischen Tonnen angegeben.

Das Gewicht des Lasthakens bzw. der Hakenflasche und weiterer Anschlagmittel ist von der Tragfähigkeit abzuziehen.

Die Tragfähigkeiten für den Teleskopausleger gelten nur bei demontierter Spitze.

Die Ausladung ist der horizontale Abstand von Mitte Drehkranz bis Mitte freihängender, nicht schwingender Last.

Tragfähigkeitsänderungen vorbehalten.

Obige Angaben dienen nur zur Information. Die Bedienungsanleitungen müssen zu Rate gezogen werden, bevor die Maschine in Betrieb genommen wird. Alle hier gemachten Angaben beziehen sich auf die Standard-Ausführung. Jegliche Ausrüstungsveränderungen können die angegebenen Werte beeinflussen.

Remarks concerning the load charts

The lifting capacities in the structural area are based on DIN 15018 parts 2 and 3 and F.E.M.

The lifting capacities in the stability area are based on DIN 15019 part 2 / ISO 4305 and pr EN 13000.

The maximum permissible wind speed for crane operation is 15 m/sec.

The lifting capacities shown are in metric tons.

The weight of load handling devices such as hook blocks, slings, etc., must be considered as part of the load and must be deducted from the lifting capacities.

The lifting capacities for the telescopic boom apply to a crane with no boom extensions being stowed or mounted on the crane.

The working radius is the horizontal distance from the centre of rotation to the centre of the freely suspended non-oscillating load.

The lifting capacities are subject to change without prior notice.

The above remarks are for basic information only and the operator's manual must be consulted before operating this crane. All data and performances refer to the standard crane. The addition of optional and other equipment may affect the performance of the crane.

Remarques relatives aux tableaux des charges

Les forces de levage sont conformes aux normes DIN 15018, p. 2 et 3, et F.E.M.

Les forces de levage dans la partie de stabilité au renversement sont conformes aux normes DIN 15019, chap. 2 / ISO 4305 et pr EN 13000.

La grue peut travailler aux vitesses de vent allant jusqu'à 15 m/s.

Les forces de levage sont données en tonnes métriques.

Le poids du crochet-moufle et de tous les accessoires d'élingage font partie de la charge et sont à déduire des charges indiquées.

Les forces de levage indiquées pour la flèche télescopique s'entendent flèche déposée.

Comme portée, on entend la distance horizontale du centre de la couronne de rotation au centre de la charge librement suspendue et non oscillante.

Sauf modification de forces de levage.

Les données ci-dessus servent à titre d'information. Avant la mise en marche de la grue il est conseillé d'étudier les instructions de service. Toutes les données indiquées ci-dessus se réfèrent à la machine de base. Tout changement de l'équipement de la grue peut influencer ces valeurs.

Notas relativas a los graficos de carga

En cuanto a los datos referentes a resistencia, las capacidades de carga están basados sobre las normas DIN 15018, pág. 2 y 3, y F.E.M.

En cuanto a los datos referentes a estabilidad anti-vuelco, las capacidades de carga están basados sobre las normas DIN 15019, Cap. 2 / ISO 4305 y pr EN 13000.

La velocidad anemométrica max. admisible es de 15 m/seg.

Las capacidades de carga indicadas en las tablas corresponden a toneladas métricas.

Hay que deducir los pesos del gancho o del motón y de otros dispositivos para fijación de cargas de los valores de capacidad de carga indicados en las tablas.

Las capacidades de carga referentes a la pluma telescópica rigen solamente si la punta está desmontada.

Como alcance se entiende la distancia horizontal desde el centro de la corona de rodaduras hasta el centro de la carga suspendida libremente y no oscilante.

Salvo modificación de capacidades de carga.

Los datos arriba indicados sirven solamente para su información. Hay que leer las instrucciones para el uso antes de la puesta en servicio de la máquina. Todos los datos mencionados en las presentes tablas rigen para los modelos standard. Cualquier modificación del equipo montado puede dar lugar a modificaciones de aquellos valores.



TADANO FAUN

ATF 70-4

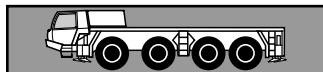

Rahmen Verwindungs- und biegesteife Schweißkonstruktion aus hochfestem Feinkorn-Baustahl in Kastenbauweise.

Abstützung 4-Punkt-Doppelteleskopabstützungen mit hydraulisch ausschiebbaren Stützträgern. Bedienungsmöglichkeiten an beiden Seiten des Fahrgestelles und von der Krankabine. Stützbasis 7,20 m und 5,00 m.

Motor (EURO 2) Mercedes-Benz 6-Zylinder-Dieselmotor OM 501 LA wassergekühlt. Leistung 290 kW (394 PS) bei 1800 U/min. Drehmoment 1850 Nm (187 kpm) bei 1080 U/min.

Getriebe Allison-Automatgetriebe HD 4060 P mit hydrodynamischem Drehmomentwandler. Wandler mit „Lock-up“ Kupplung, 6 Vorwärts- und 1 Rückwärtsgang. Zweistufiges Verteilergetriebe VG 1200 mit Straßen- und Geländegang.

Antrieb 8 x 6 (8 x 8*).

Achsen

1. Achse: gelenkt, angetrieben.
 2. Achse: gelenkt, nicht angetrieben.
 3. Achse: gelenkt, angetrieben, mit Vorgelegedifferential.
 4. Achse: gelenkt, angetrieben.
- Quersperren in allen Antriebsachsen.

Achsaufhängung Hydropneumatische Federung mit Niveauregulierung.

Bremsen Druckluft-Zweikreis-Bremsanlage. Feststellbremse als Federspeicherbremse an der 2., 3., und 4. Achse wirkend. Dauerbremse: Konstantdrosselanlage und Auspuffklappenbremse, Wirbelstrombremse*.

Räder 8-fach 16.00 R 25 Straßen- und Geländeprofil.

Lenkung Vom Fahrgestell: ZF-Halbblock-Zweikreishydrolenkung, mechanische Lenkung der 2 Vorderachsen, hydraulisch unterstützt und mit Notlenkpumpe. Verfahren vom Oberwagen: Fremdkraft-Hydrolenkung, 3 Lenkmöglichkeiten: Lenkung der 1. + 2. Achse, Allrad und Hundegang.

Fahrerhaus Zweimann-Frontfahrerhaus in Stahl-Kunststoff-Verbundkonstruktion, Sicherheitsverglasung, luftgefederter Fahrer- und Beifahrersitz. Motorabhängige Warmwasserheizung, Kontroll- und Bedienungselemente für den Fahrbetrieb.

Elektrische Anlage 24 Volt Gleichstrom, 2 Batterien, nach der EG-Regulation.

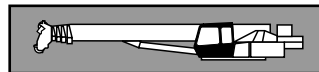

Rahmen Verwindungssteife Schweißkonstruktion mit einer außenverzahnten, einreihigen Kugeldrehverbindung, um 360° unbegrenzt drehbar.

Motor (EURO 2) Mercedes-Benz 4-Zylinder-Dieselmotor OM 904 LA mit 90 kW (123 PS) bei 2300 U/min, wassergekühlt. Leistung nach DIN 6270 B.

Hydraulik-System Diesel-hydraulisch, 3-Kreis-Hydraulik, 1 leistungsgeregelte Axialkolbendoppelpumpe (hydraulisch verstellbar, Cross-Sensing), 1 Zahnraddoppelpumpe.

Steuerung Zwei 4-fach Kreuzsteuerhebel mit hydraulischer Vorsteuerung.

Teleskopausleger Fünfteiliger, kastenförmiger Teleskopausleger aus hochfestem Feinkornstahl, bestehend aus einem Grundausleger und 4 Teleskopteilen, unter Teillast teleskopierbar. 10,5 m – 40,5 m lang.

Auslegerverlängerung* Teleskop-Spitzenausleger, seitlich klappbar 9,0 – 16,0 m lang, unter 4°/15°/30° abwinkelbar.

Wippwerk 1 Differentialzylinder mit angebautem Sicherheitsventil.

Hubwerk Axialkolben-Konstant-Motor, Hubwerkstrommel mit eingebautem Planetengetriebe und federbelasteter Hydro-Lamellenbremse mit integriertem Freilauf beim Heben.

Drehwerk Konstant-Motor, zweistufiges Planetengetriebe mit fußbetätigter Betriebsbremse und Feststellung. Drehgeschwindigkeit stufenlos von 0 – 2,0 U/min.

Gegengewicht Gesamtgewicht 8,9 t teilbar (12,1 t* teilbar), gesteuert von der Krankabine.

Krankabine Großräumige Krankabine in Stahlblechausführung, großflächige Sicherheitsverglasung mit getönten Scheiben, verstellbarem hydraulisch gedämpften Fahrersitz. Motorabhängige Warmwasserheizung. Kontroll- und Bedienungselemente für den Kran- und Baustellenfahrbetrieb.

Elektrische Anlage 24 Volt Gleichstrom, 2 Batterien.

Sicherheitseinrichtung Elektronische Lastmomentbegrenzung (LMB), Sicherheitsventile gegen Rohr- und Schlauchbrüche, Windensdshalter, Seilwindendrehmelder und Hubendschalter.

*) Gegen Mehrpreis / Änderungen vorbehalten

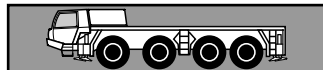
**TADANO FAUN****ATF 70-4**

Frame Box-type, torsion resistant, welded construction made of high tensile steel with integral outrigger housings.

Outriggers Four point, fully hydraulic, double telescopic. Controls in crane cab and on both sides of carrier with level gauges. Outrigger spread 7.2 m (mid extension 5.0 m).

Carrier engine (EURO 2) Mercedes-Benz 6 cylinder, diesel, water-cooled engine, model OM 501 LA. Rating 290 kW (394 HP) at 1800 rpm. Torque 1850 Nm (187 kpm) at 1080 rpm.

Transmission Allison automatic transmission HD 4060 P and hydro-dynamic torque converter with "lock-up" 6 forward gears and 1 reverse gear. Transfer case (two stage) Steyr VG 1200 with on- and off-road range.

Drive 8 x 6 (8 x 8*).

Axles

1st axle: steering and driven.

2nd axle: steering, non- driven.

3rd axle: steering and driven, with auxiliary reduction gear.

4th axle: steering and driven.

Transverse differential lock in all driven axles.

Suspension Hydro-pneumatic with levelling adjustment.

Brake system Service brakes: dual circuit compressed air system. Parking brake: spring loaded type acting on 2nd, 3rd and 4th axles. Auxiliary brake: Engine exhaust brake and constant throttle valve system, Eddy current retarder brake*.

Wheels (8) 16.00 R 25 on/off road profile tyres.

Steering system From carrier cab: ZF dual circuit semi-block mechanical steering of front two axles with hydraulic booster and transmission-mounted emergency pump. From crane cab: hydro-static steering with 3 steering modes: front 2 axle steer, all wheel steer and crab steer.

Carrier cab Two man full width cab of composite (steel sheet metal and fibre-glass) structure, with safety glass, air cushioned adjustable seats, motor dependent warm-water heater. Complete controls and instrumentation for road travel.

Electrical system 24 volt DC system with 2 batteries. Lighting according to EEC regulations.

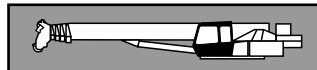

Frame Torsion-resistant all-welded structure of high strength steel. Connected to carrier by single-row ball slewing ring with external gearing for 360° continuous rotation.

Crane engine (EURO 2) Mercedes-Benz 4 cylinder, diesel, water cooled engine, model OM 904 LA rated at 90 kW (123 HP) at 2300 rpm (according to DIN 6270 B).

Hydraulic system Three circuit diesel hydraulic system with 1 double axial piston variable displacement pump (hydraulically adjustable with cross-sensing) and 1 double gear pump.

Hydraulic controls 2 joy-stick levers for simultaneous crane motions, infinitely controlled.

Telescopic main boom Five section box type construction of high tensile, fine-grained steel consisting of 1 base section and 4 telescoping sections. All sections hydraulically extendable under partial load. 10.5 – 40.5 m long.

Boom extension* Swing-around, telescopic boom extension 9.0 – 16.0 m long, offsets 4°/15°/30°.

Boom hoist 1 double acting hydraulic cylinder with integral holding valve.

Main winch Axial piston constant displacement motor, hoist drum with planetary reduction and spring-loaded, multiple disc brake.

Slewing gear Constant displacement motor with two-stage planetary gear with a foot actuated service brake and a parking brake. Slewing speed infinitely variable: 0 – 2.0 rpm.

Counterweight Total 8.9 t divisible, controlled from crane cab (12.1 t* divisible).

Crane cab Spacious all-steel comfortable panoramic cab with special tinted safety glass, hydraulically cushioned and adjustable seat, engine dependent hot-water heater. Controls and instrumentation for crane operation and on-site travelling.

Electrical system 24 volt DC system with 2 batteries.

Safety devices Load moment device (LMD). Safety valves against pipe and hose rupture, holding valves on hydraulic cylinders, lower limit switch on main winch, drum turn indicator and hoist limit switch.



TADANO FAUN

ATF 70-4

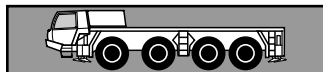

Châssis Construction mécano-soudée, en forme de caisson, résistante aux flexions et aux torsions.

Calage 4 poutres extensibles hydrauliquement à partir de la cabine du grutier et latéralement à gauche et à droite du châssis. Largeur de calage 7,20 m et 5,00 m.

Moteur (EURO 2) Mercedes-Benz diesel OM 501 LA 290 kW (394 CV à 1800 tr/min) refroidi par eau. Couple-moteur: 1850 Nm (187 Kpm) à 1080 tr/min.

Boîte de vitesses Boîte Allison-Full powershift HD 4060 P avec convertisseur de couple. Convertisseur avec embrayage lock-up avec 6 vitesses AV et 1 AR. Boîte de transfert bi-étagée VG 1200 avec rapport route et tout terrain.

Entraînement
8 x 6 (8 x 8*).

Essieux
1^{er} essieu avant: moto-directeur.
2^{ème} essieu avant: directeur, non-entraîné.
3^{ème} essieu: moto-directeur avec boîte de renvoi.
4^{ème} essieu: moto-directeur.
Réduction planétaire dans tous les essieux.

Suspension
Hydropneumatique, réglage d'inclinaison à suspension bloquée.

Freins Frein de service: système de frein à air comprimé à double circuit.
Frein de parcage: Frein à ressorts accumulateurs agissant sur le 2^{me}, 3^e et 4^e essieu.
Frein continu: frein sur échappement et étrangleur, frein à courant électrique*.

Pneumatique 8 pneus de 16.00 R 25

Direction Direction hydraulique ZF semi-bloc à 2 circuits depuis la cabine de conduite. Commande mécanique des 2 essieux avant, assistée hydrauliquement et avec pompe de direction auxiliaire. Direction hydrostatique depuis la cabine tourelle. 3 possibilités de direction: Commande 1^{er} et 2^{me} essieu, commande 4 essieux, marche en crabe.

Cabine du conducteur Cabine bi-place, construction en matière combinée, avec vitrage en verre de sécurité, siège de conducteur et du co-pilote à suspension pneumatique. Chauffage à eau relié au moteur, organes de commande et de contrôle pour conduire la grue.

Système électrique 24 V courant continu, 2 batteries, éclairage conforme au code de la route de la C.E.E.

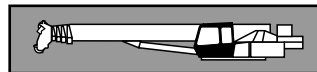

Plate forme Construction mécano-soudée, résistante à la torsion. Couronne d'orientation avec denture extérieure, permettant une rotation illimitée de 360°.

Moteur (EURO 2) Moteur Diesel DB, type OM 904 LA avec 4 cylindres et une puissance de 90 kW (123 CV), à 2300 min⁻¹ refroidi par eau. Puissance selon DIN 6270 B.

Système hydraulique Diesel-hydraulique, avec 3 circuits, comprenant 1 double pompe à pistons axiaux à régulation de puissance (réglable hydrauliquement, système cross-sensing) et 1 double pompe à engrenages.

Commandes 2 manipulateurs à commande en croix, assistés hydrauliquement.

Mécanisme de relevage Vérin différentiel muni de clapet de sécurité.

Mécanisme de rotation Moteur hydraulique avec entraînement planétaire à 2 gammes. Frein de service actionné par l'intermédiaire d'une pédale et frein de stationnement. Vitesse de rotation 0 à 2,0 tr/min.

Mécanisme de levage Moteur hydraulique, tambour de levage avec engrenage planétaire incorporé, frein d'arrêt à disques multiples à ressort, libéré lors du levage.

Flèche télescopique 1 élément de base et 4 éléments télescopiques, télescopables hydrauliquement sous charge. Flèche en forme de caisson et en acier à grain fin à haute résistance. Longueur de flèche: 10,5 m à 40,5 m.

Rallonge de flèche* Construction en treillis avec rallonge mécanique de 9,0 m à 16,0 m, rabattable latéralement et inclinable à 4° / 15° / 30°.

Contrepoids Poids total 8,9 tonnes (12,1 tonnes*) Poids divisible, commandé de la cabine de conduite.

Cabine de conduite En acier avec vitrage de sécurité, siège suspendu sur ressort, amorti hydrauliquement et réglable. Chauffage à eau chaude dépendant du moteur. Tableau de bord avec instruments de contrôle aussi bien pour le déplacement que pour les mouvements sur chantier.

Equipement électrique 24 V courant continu, 2 batteries.

Dispositifs de sécurité Contrôleur électronique de charge (CEC), clapets anti-retour contre rupture des conduites et flexibles, fin de course du treuil pour câble de levage, indicateur du nombre de tours sur tambour de treuil et interrupteur fin de course de levage.

*) Contre supplément de prix / Cette documentation est modifiable sans préavis



TADANO FAUN

ATF 70-4

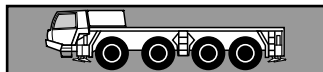

Chasis Construcción de tipo de caja de acero de alta resistencia soldado, resistente a la torsión, con alojamientos integrales para los estabilizadores.

Estabilizadores Telescópicos dobles, totalmente hidráulicos, de cuatro puntos. Controlados desde la cabina de la grúa y desde ambos lados del chasis portante con manómetros de nivel. Extensión de los estabilizadores: 7,20 m y 5,00 m.

Motor del chasis portante Mercedes-Benz modelo OM 501 LA (EURO 2), 6 cilindros diesel, refrigerado por agua. Nominal 290 kW (394 HP) a 1800 rpm. Par 1850 Nm (187 kpm) a 1080 rpm.

Transmisión Caja de cambios automática Allison HD 4060 P con convertidor de par hidro-dinámico. Convertidor con embrague "Lock-up", 6 marchas hacia adelante y 1 marcha atrás. Caja de reenvío VG 1200, de 2 grupos de desmultiplicación para marcha en carretera y de todo-terreno.

Tacción 8 x 6 (8 x 8*).

Ejes

1^{er} eje: de dirección, accionado.

2^o eje: de dirección, no accionado.

3^{er} eje: de dirección accionado, con diferencial de desmultiplicación.

4^o eje: de dirección accionado.

Con bloqueo diferencial transversal en todos los ejes accionados.

Suspensión Hidroneumática con ajuste de nivelación.

Sistemas de frenos Freno de servicio: sistema de aire comprimido de doble circuito. Freno de estacionamiento: de tipo cargado por resortes, actuando sobre los ejes 2^o, 3^o y 4^o. Freno continuo: sistema de estrangulador permanente y con chapaleta de escape, freno de contracorriente*.

Neumáticos (8) neumáticos 16.00 R 25 con dibujo para carretera y fuera de ella.

Sistema de dirección Desde la cabina del chasis portante: dirección mecánica con semibloqueo de doble circuito ZF de dos ejes delanteros con reforzador hidráulico y bomba de emergencia montada en la transmisión. Desde la cabina del chasis portante: dirección hidro-estática con 3 modos de dirección: dirección de 2 ejes delanteros, dirección de todas las ruedas y dirección de cangrejo.

Cabina del chasis portante Cabina de anchura total para dos hombres, de estructura compuesta (chapa de acero y fibra de vidrio), con lunas de seguridad, sillones amortiguados por aire para el camionero y su asistente, calentador de agua caliente dependiente del motor. Controles completos e instrumentos para circulación por carretera.

Sistema eléctrico Sistema a 24 V c.c. con 2 baterías, iluminación de acuerdo con las normas CEE.

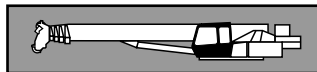

Superestructura Estructura de acero de alta resistencia, toda soldada, resistente a la torsión. Conectada al chasis mediante la corona de giro de una fila de bolas, con engranaje externo para rotación continua de 360°.

Motor de la grúa Motor Mercedes-Benz modelo OM 904 LA (EURO 2), 4 cilindros, diesel, refrigerado por agua, nominal 90 kW (123 HP) a 2300 rpm (de acuerdo con normas DIN 6270 B).

Sistema hidráulico Sistema hidráulico de tres circuitos, con una bomba doble de pistones axiales de caudal variable (hidráulicamente regulable con sensor cruzado) y una bomba de engranajes doble.

Controles hidráulicos 2 palancas de control infinito de tipo universal (joy-stick) para movimientos simultáneos de la grúa.

Pluma principal telescópica Construcción de tipo de caja, de acero de grano fino de alta resistencia, con cinco tramos, un tramo de base y cuatro tramos telescópicos. Todos los tramos se extienden hidráulicamente bajo carga, longitud de 10,5 a 40,5 m.

Prolongación de la pluma Prolongación de la pluma telescópica, abatible lateralmente, de 9,0 - 16,0 m de longitud, angularable a 4° / 15° / 30°.

Elevación de la pluma Un cilindro hidráulico de doble efecto con válvula de retención integrada.

Cabrestante principal Motor de pistones axiales de desplazamiento constante, tambor de elevación con reducción planetaria y freno multidisco cargado por resortes.

Sistema de giro Motor de desplazamiento constante con engranaje planetario de dos etapas, con freno de servicio controlado con el pie y freno de estacionamiento. Velocidad de giro infinitamente variable: 0 - 2,0 rpm.

Contrapeso Total de 8,9 ton divisible. (12,1 ton divisible*), accionado de la cabina de la grúa.

Cabina de la grúa Cabina panorámica, espaciosa y confortable, toda de acero, con lunas de seguridad tintadas especiales, con sillón regulable amortiguado hidráulicamente y calentador a agua caliente dependiente del motor. Completa con controles e instrumentos para la operación de la grúa y para el desplazamiento en la obra, en solar.

Sistema eléctrico Sistema a 24 V c.c. con 2 baterías.

Dispositivos de seguridad Dispositivo de momento de carga (LMD). Válvulas de seguridad contra rotura de tuberías y latiguillos, válvulas de retención en los cilindros hidráulicos, interruptor de límite de bajada en el cabrestante principal, indicador de vueltas del tambor e interruptor final de elevación.



TADANO FAUN

ATF 70-4

Hakenhöhen / Kopfhöhen
 Hook height / Tip height
 Hauteurs sous crochet / Hauteurs tête de flèche
 Altura del gancho / Altura de la punta

